









■ Standard Accessories

			CM-36dG	CM-36dGV	CM-36d
AC Adapter	AC-A312F		●	●	●
USB Cable (2 m)	IF-A17		●	●	●
White Calibration Plate	CM-A288		●	●	●
Gloss Calibration Plate	CM-A289		●	●	—
Zero Calibration Box	CM-A290		●	—	●
Zero Calibration Box	CM-A119		—	●	—
Target Mask (LAV)	CM-A291		●	●	●
Target Mask (LMAV)	CM-A292		●	●	—
Target Mask (MAV)	CM-A293		●	●	●
Target Mask (SAV)	CM-A294		●	●	●
Dust Cover	CM-A295		●	—	●
Dust Cover	CM-A118		—	●	—
Accessory Case	CM-A286		●	●	●
Cleaning Cloth	—		●	●	—

■ Optional Accessories

			CM-36dG	CM-36dGV	CM-36d
Color Data Software SpectraMagic NX	CM-S100w		●	●	●
Transmittance Specimen Holder	CM-A96		●	●	—
Glass Cell (2 mm)	CM-A97		●	—	—
Glass Cell (10 mm)	CM-A98				
Glass Cell (20 mm)	CM-A99				
Plastic Cell (2 mm)	CM-A130		●	—	—
Plastic Cell (10 mm)	CM-A131				
Plastic Cell (20 mm)	CM-A132				
Transmittance Zero Calibration Plate	CM-A100		●	●	—
Opacity Jig	CM-A134		—	●	—
Color Plate (White)	CM-A247		●	●	●
Color Plate (Pale Gray)	CM-A248				
Color Plate (Mid Gray)	CM-A249				
Color Plate (Diff Gray)	CM-A250				
Color Plate (Deep Gray)	CM-A251				
Color Plate (Deep Pink)	CM-A252				
Color Plate (Red)	CM-A253				
Color Plate (Orange)	CM-A254				
Color Plate (Yellow)	CM-A255				
Color Plate (Green)	CM-A256				
Color Plate (Diff Green)	CM-A257				
Color Plate (Cyan)	CM-A258				
Color Plate (Deep Blue)	CM-A259				
Color Plate (Black)	CM-A260				

CM-36dG

System Diagram

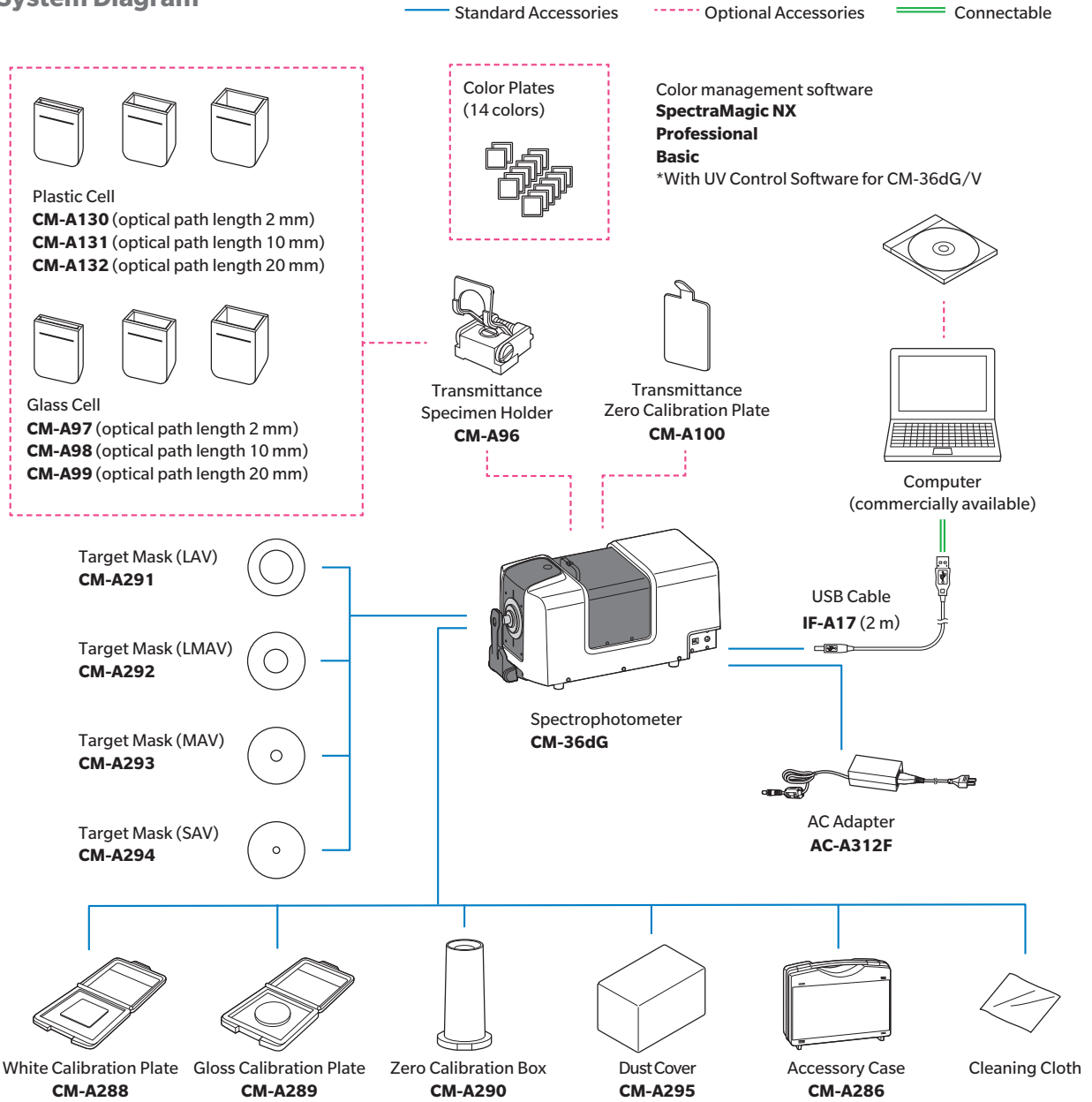

Dimensions

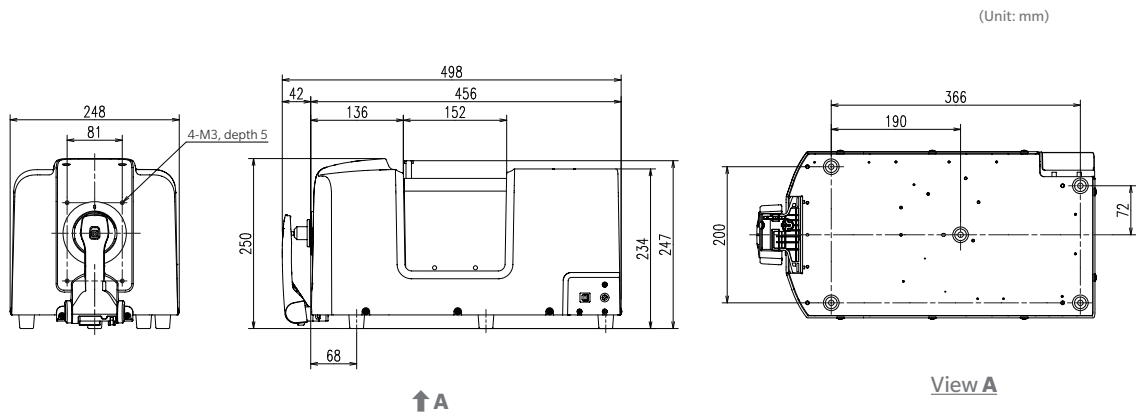

CM-36dGV

System Diagram

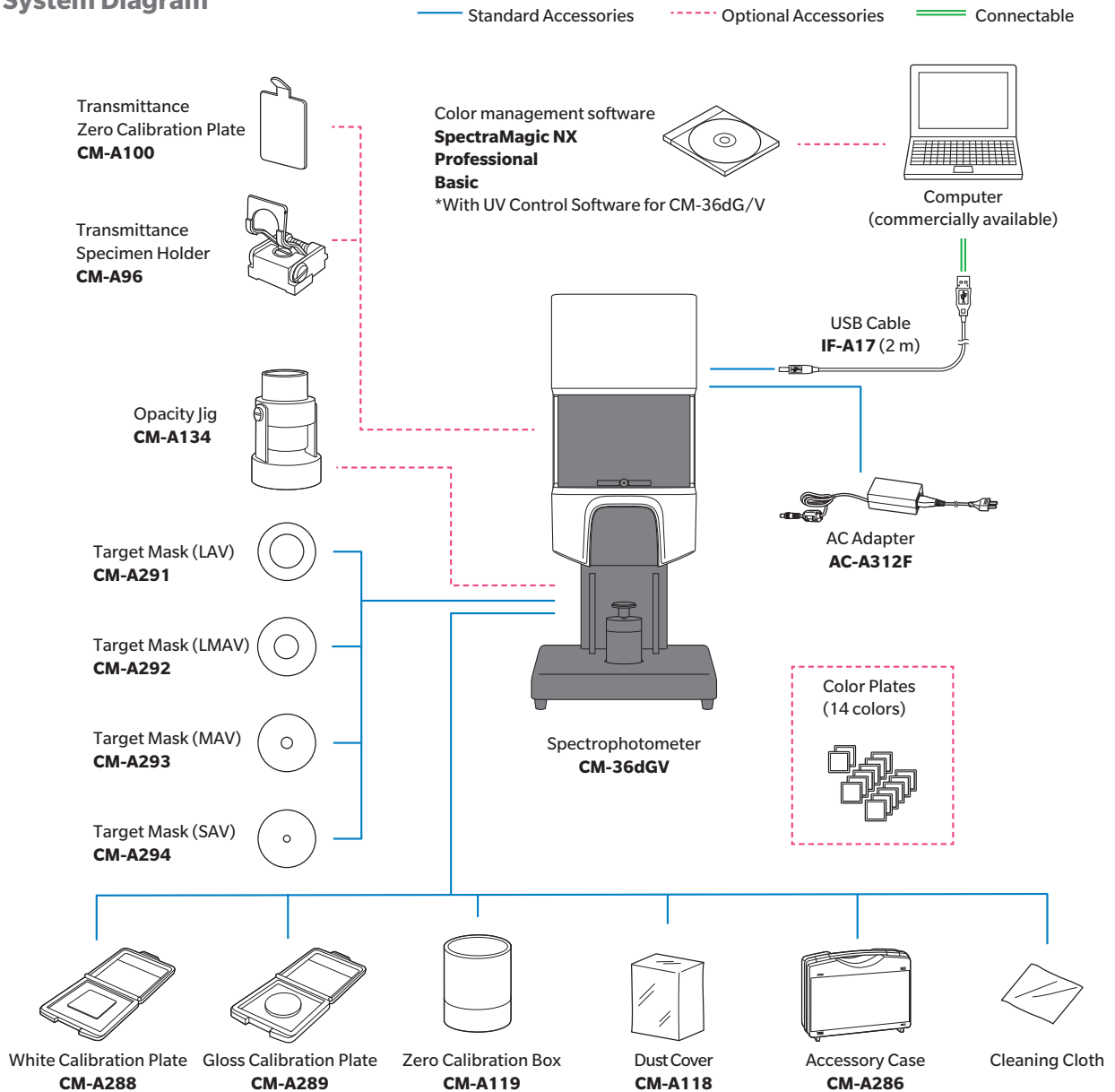

Dimensions

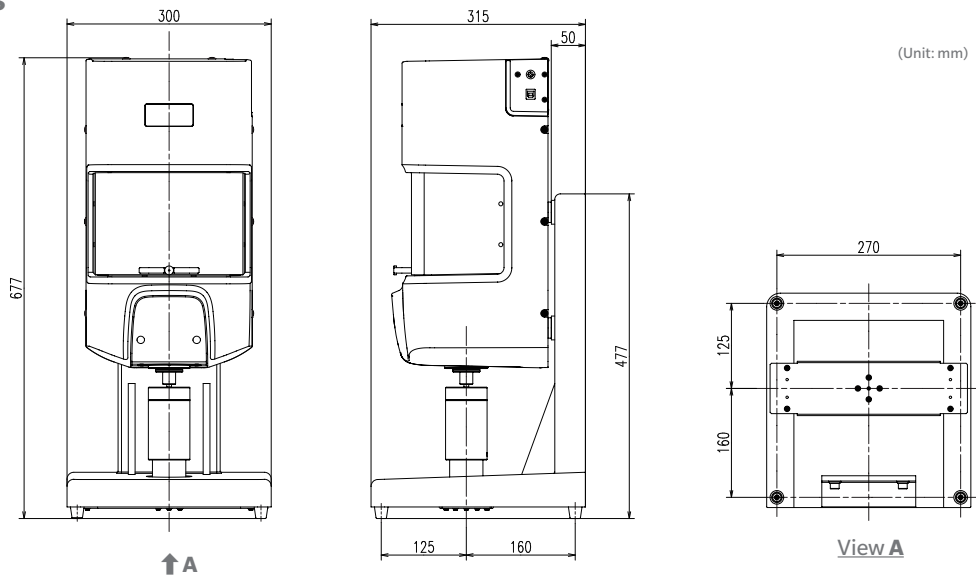

System Diagram

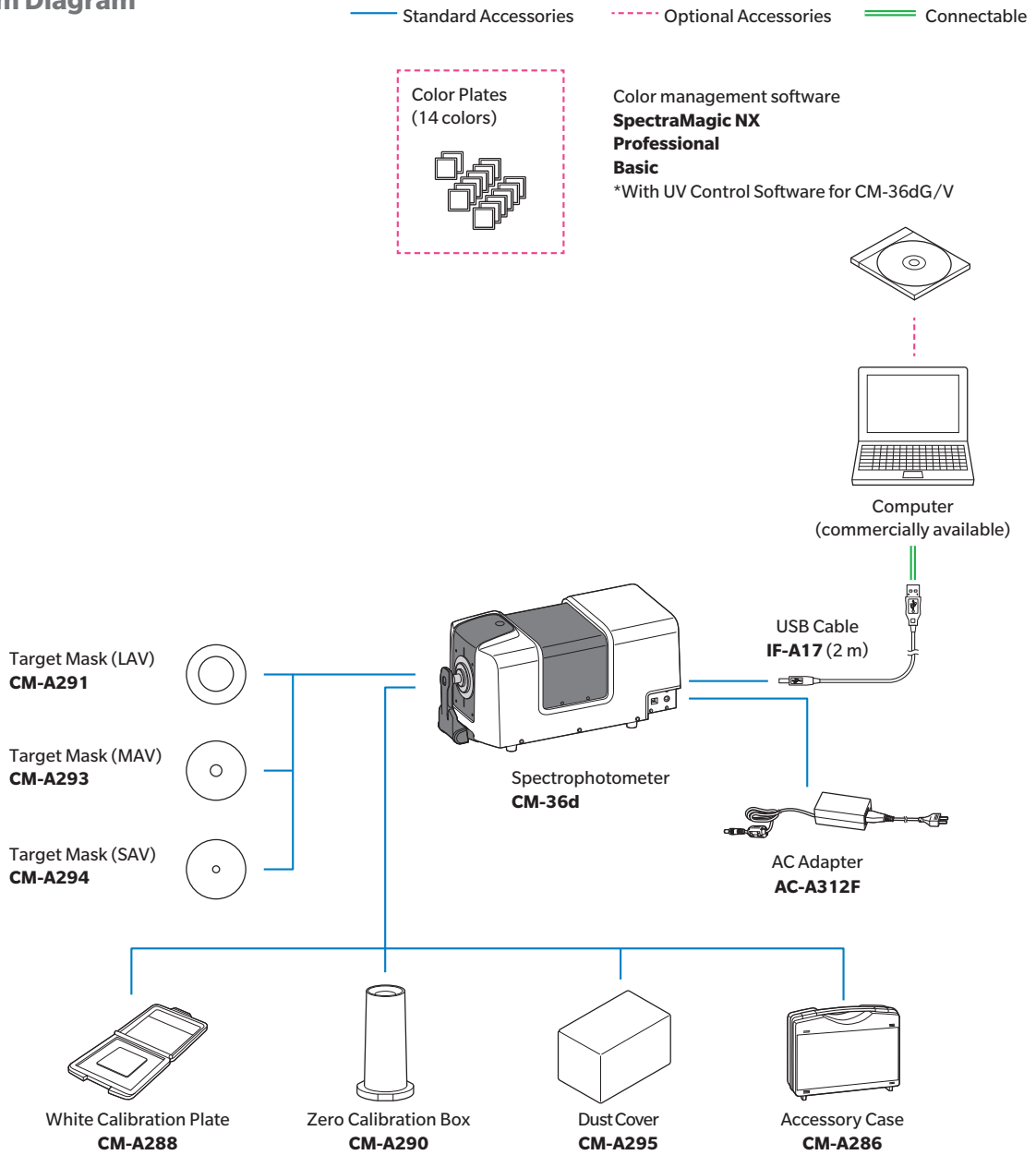

Dimensions

